

12TH INTERNATIONAL JUNIOR SCIENCE OLYMPIAD

IJSO-2015

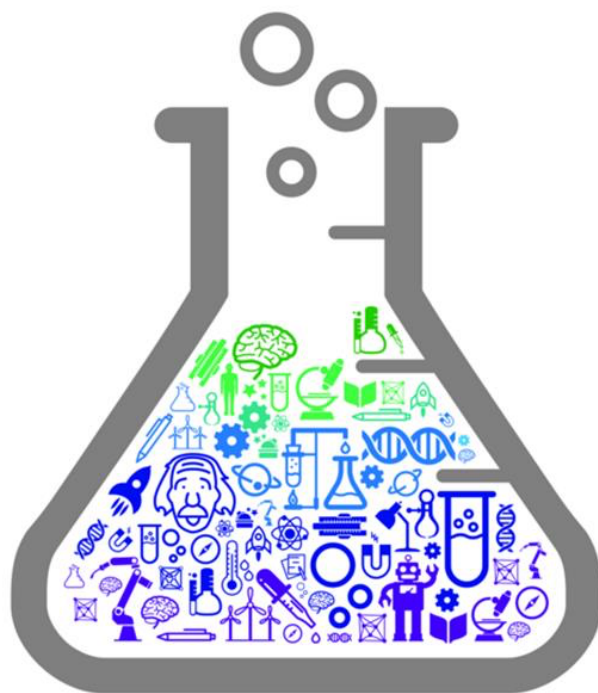

December 2(Wed)-11(Fri), 2015 | Daegu, Republic of Korea

Theoretical Competition

– **Solution** –

December 6, 2015



SOLUTION

I. Chemical Oxygen Demand (COD) Test

I-1

I-1-1 [0.5 points]

(Answer) $a + b/4 - c/2$

(Explanation) Balance the masses of O for both sides.

$$c + 2x = 2a + 0.5b \quad [0.3 \text{ points}]$$

$$x = a + 0.25b - 0.5c \quad [0.2 \text{ points}]$$

I-1-2. [0.5 points]

(Answer) $8y$

(Explanation) Balance the charges for both sides.

$$(-2)y + (+1)z = 2y(+3) \quad [0.3 \text{ points}]$$

$$z = 8y \quad [0.2 \text{ points}]$$

I-1-3. [0.5 points]

(Answer) $2a/3 + b/6 - c/3$

(Explanation)

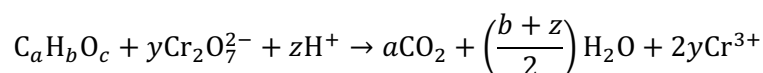

Balance the masses of O.

$$c + 7y = 2a + 0.5b + 0.5z \quad [0.2 \text{ points}]$$

Substitute $8y$ for z

$$3y = 2a + 0.5b - c \quad [0.2 \text{ points}]$$

$$y = 2a/3 + b/6 - c/3 \quad [0.1 \text{ points}]$$

I-1-4. [0.5 points]

(Answer) $3y/2$

(Explanation)

From the former questions,

$$x = a + b/4 - c/2 \quad [0.1 \text{ points}]$$

$$y = 2a/3 + b/6 - c/3 = (2/3) \times (a + b/4 - c/2) \quad [0.2 \text{ points}]$$

Therefore, $x = 3y/2$ [0.2 points]



I-2

I-2-1. [1.0 point]

(Answer) 6

(Explanation)

(Method 1) Balance the charge sums on both sides.

$$-2 + 2f + 14 = +6 + 3f \quad [0.5 \text{ points}]$$

$$f = 6 \quad [0.5 \text{ points}]$$

(Method 2) The electron flows for the redox pairs can be compared

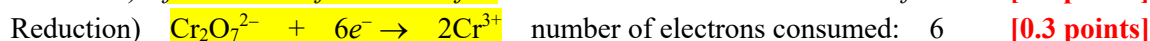
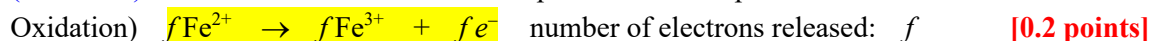

$$f = 6 \quad [0.5 \text{ points}]$$

I-2-2. [1.0 point]

(Answer) 6.0×10^{-5}

(Explanation)

The titration in the step (B) involves the redox reaction of Fe and Cr.

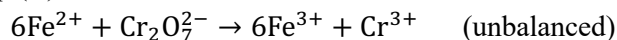

As the reduction of $\text{Cr}_2\text{O}_7^{2-}$ (Cr^{6+}) to 2Cr^{3+} has to be coupled by oxidation of $6\text{Fe}^{2+} \rightarrow 6\text{Fe}^{3+}$, titration of $\text{Cr}_2\text{O}_7^{2-}$ requires 6 equivalents of Fe^{2+} . [0.2 points]

That is, at the beginning of step (B), the amount of $\text{K}_2\text{Cr}_2\text{O}_7$ was $(1.20 \times 10^{-3})/6 = 2.00 \times 10^{-4}$ mol. [0.5 points]

So, 6.0×10^{-5} ($= 2.60 \times 10^{-4} - 2.00 \times 10^{-4}$) mol of $\text{K}_2\text{Cr}_2\text{O}_7$ had been consumed for oxidizing pollutants. [0.3 points]

I-2-3. [1.0 point]

(Answer) 288

(Explanation)

 6.0×10^{-5} mol of $\text{K}_2\text{Cr}_2\text{O}_7$ were required to treat 10.0 mL of waste water.

Thus, 1.00 L of waste water should require 6.0×10^{-3} mol of $\text{K}_2\text{Cr}_2\text{O}_7$. [0.2 points]

Equivalently this corresponds to 9.0×10^{-3} mol ($= 6.0 \times 10^{-3}$ mol $\times 3/2$) [0.3 points] and 0.288 g (9.0×10^{-3} mol $\times 32$) = 288 mg of O_2 [0.3 points].

Then, the COD can be expressed as 288 ppm. [0.2 points]

**I-2-4. [2.0 points]**

(Answer) 93.6, 0.176

(Explanation)

1 mole of C₆H₆ can be fully decomposed by 7.5 moles of O₂.Or express chemical equation. $C_6H_6 + \frac{15}{2}O_2 \rightarrow 6CO_2 + 3H_2O$ [0.3 points]So, 9.0×10^{-3} mol of O₂ corresponds to $9.0 \times 10^{-3} \text{ mol} / 7.5 = 1.2 \times 10^{-3}$ mol [0.3 points]C₆H₆ : $0.0012 \text{ mol} \times \left(\frac{78 \text{ g}}{1 \text{ mol}}\right) = 0.0936 \text{ g} = 93.6 \text{ mg}$ [0.4 points]1 mole of C₆H₆ is decomposed to 6 moles of CO₂. [0.2 points]Therefore in the present case, 7.2×10^{-3} moles (= $1.2 \times 10^{-3} \text{ mol} \times 6$) of CO₂ are evolved. [0.3 points]

[0.3 points]

CO₂ volume is calculated as followed: $PV = nRT$ [0.2 points] $V = \frac{(7.2 \times 10^{-3} \text{ mol})(0.0821 \text{ L}\cdot\text{atm}/\text{mol}\cdot\text{K})(298 \text{ K})}{1.00 \text{ atm}} = 0.176 \text{ L}$ [0.3 points]**I-2-5. [1.0 point]**(Answer) 1.2×10^{-4} , 5.2×10^{-4}

(Explanation)

Initially, there were 2.60×10^{-4} moles of Cr₂O₇²⁻ but no Cr³⁺ in the test system. [0.1 points]

From the results of titration with Fe²⁺, we figure that 2.00×10^{-4} moles of Cr₂O₇²⁻ were present at the beginning of step (B), which means that 0.60×10^{-4} moles of Cr₂O₇²⁻ were used to decompose the pollutant and to produce the 1.20×10^{-4} (= $0.60 \times 10^{-4} \times 2$) moles of Cr³⁺ before the Fe²⁺ titration. [0.4 points]

In the step (B), 2.00×10^{-4} moles of Cr₂O₇²⁻ were used and 4.00×10^{-4} (= $2.00 \times 10^{-4} \times 2$) moles of Cr³⁺ ions produced. [0.3 points]

Therefore the concentration of Cr³⁺ ions after Fe²⁺ titration is 5.20×10^{-4} (= $4.00 \times 10^{-4} + 1.20 \times 10^{-4}$) moles. [0.2 points]

	Amounts present	
	Cr ₂ O ₇ ²⁻	Cr ³⁺
Initial	$2.60 \times 10^{-4} \text{ mol}$	0
Change during step (A)	$-0.60 \times 10^{-4} \text{ mol}$	$+1.2 \times 10^{-4} \text{ mol}$
After step (A)/ Before step (B)	$2.00 \times 10^{-4} \text{ mol}$	$1.2 \times 10^{-4} \text{ mol}$
Change during step (B)	$-2.00 \times 10^{-4} \text{ mol}$	$+4.00 \times 10^{-4} \text{ mol}$
After step (B)	0	$5.2 \times 10^{-4} \text{ mol}$

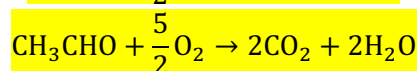
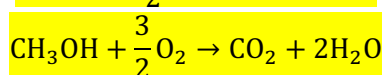
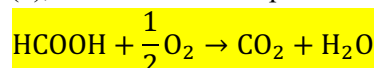
**I-3. [2.0 points]**(Answer) CH₃CHO, 18(Explanation) Based on equation (1), oxidation of each pollutant requires following amount of O₂.**[0.3 points, each 0.1 points]**

The COD of the pollutant solutions can be calculated stepwise,

	Moles of O ₂ per 1 mole pollutant	Moles of O ₂ per 10.0 mg pollutant [0.6 points] = [each 0.2 point]	COD for 10.0 mg/L pollutant solution [0.9 points] = [each 0.3 point]
HCOOH (46 g/mol)	0.5	$0.5 \times (10.0 \times 10^{-3})/46$	$32 \times 10^3 \times 0.5 \times (10.0 \times 10^{-3})/46$ = 3.5 ppm
CH ₃ OH (32 g/mol)	1.5	$1.5 \times (10.0 \times 10^{-3})/32$	$32 \times 10^3 \times 1.5 \times (10.0 \times 10^{-3})/32$ = 15 ppm
CH ₃ CHO (44 g/mol)	2.5	$2.5 \times (10.0 \times 10^{-3})/44$	$32 \times 10^3 \times 2.5 \times (10.0 \times 10^{-3})/44$ = 18 ppm

Of the three samples, CH₃CHO solution has the highest COD [0.1 points], which is 18 ppm. [0.1 points]

In any case, student who make correct answer (CH₃CHO and 18 ppm), will have full credits.



II. Ski Jumping

II-1 [0.75 points] [Correct answer: 0.25, wrong answer: 0 for each force]

(Answer) Gravitational force ⑤, Normal force ②, Air resistance ⑧

II-2 [1.5 point]

(Answer) $\mu = \frac{2gh - v^2}{2g \cos \theta \cdot s}$

(Explanation) By conservation of energy [1.0] or dynamic & kinematic [0.5 + 0.5 or proportional rating for any other method]

$$mgh - \frac{1}{2}mv^2 = \mu mg \cdot \cos \theta \cdot s$$

$$\mu = \frac{gh - \frac{1}{2}v^2}{g \cos \theta \cdot s} \quad [0.5]$$

II-3 [1.5 point]

(Answer) $t = \frac{2v_0}{g} \kappa$

(Explanation) The horizontal distance to the landing point is $N_{\text{landing}} = v_0 t$. [0.5]

The vertical distance to the landing point is $H_{\text{landing}} = \frac{1}{2}gt^2$. [0.5]

Or proportional rating for any other method

From $|\kappa| = \frac{H}{N} = \frac{H_{\text{landing}}}{N_{\text{landing}}} = \frac{\frac{1}{2}gt^2}{v_0 t}$, we can find $t = \frac{2v_0}{g} \kappa$. [possible 0.25 for using ratio in slope + 0.25 rearranging the equation]

II-4 [1.25 point]

(Answer) $D = \frac{2v_0^2}{g} \kappa \sqrt{1 + \kappa^2}$ [0.25 final answer]

(Explanation) $D = \sqrt{N_{\text{landing}}^2 + H_{\text{landing}}^2} = N_{\text{landing}} \sqrt{1 + \kappa^2} = \frac{2v_0^2}{g} \kappa \sqrt{1 + \kappa^2}$

[0.5 + 0.5 for any method steps]



SOLUTION

III. Thomson's Cathode-Ray Experiment

III-1 [1.0 point]

(Answer) $u = \sqrt{\frac{2eV_1}{m}}$

(Explanation) Potential energy of the electron at L_1 is eV_1 [0.25]. At the moment of electron passing through a slit of M_1 , kinetic energy of the electron at M_1 is $\frac{1}{2}mu^2$ [0.25], all of the potential energy converts to the kinetic energy [0.25].

$$eV_1 = \frac{1}{2}mu^2 \rightarrow u = \sqrt{\frac{2eV_1}{m}} \quad [0.25]$$

III-2.

III-2-1. [1.0 point] (Correct answer: 1 point, wrong answer: 0 point)

(Answer) ①

(Explanation) The electric force exerts on the electron. Because the charge of the electron is negative, the electric force exerts to the M_2 direction. So the trace of the electron is ①.

III-2-2. [1.0 point] (Correct answer: 1 point, wrong answer: 0 point)

(Answer) ③

(Explanation) The magnetic force exerts on the electron. Because the negative electron moves to the right and the magnetic field points into the page, the magnetic force exerts to the L_2 direction. So the trace of the electron is ③.

III-3 [1.5 point]

(Answer) $u = \frac{V_2}{Bd}$

(Explanation) When the electron flies straight (trace ②), the electric force directed to M_2 and the magnetic force directed to L_2 are compensated with the same magnitude ($\sum F = 0$ or $F_E = F_B$ 0.5 point). Then, $\frac{eV_2}{d} = euB$. [0.5] The speed of the electron is $= \frac{V_2}{Bd}$. [0.5]

III-4 [0.5 point]

(Answer) $\frac{e}{m} = \frac{V_2^2}{2B^2d^2V_1}$

(Explanation) $u = \sqrt{\frac{2eV_1}{m}} = \frac{V_2}{Bd} \rightarrow \frac{e}{m} = \frac{V_2^2}{2B^2d^2V_1}$ (0.25 point for $u_{III-2} = u_{III-3}$)

(0.25 point for rearranging the formula)



IV. Excretory System

(Explanation) The blood arrives through the renal artery and leaves in the renal vein. The kidneys produce urine which is carried to the bladder along the ureter. There are three major anatomical demarcations in the kidney: the cortex, the medulla, and the renal pelvis. The cortex receives most of the blood flow, and is mostly concerned with reabsorbing filtered material.

X is protein. Y is glucose. Z is urea. Water is filtered from the glomerulus to the Bowman's capsule and re-absorbed, and discharged to form urine. Urea is the substance to be filtered, so is in both the plasma and the filtrate. Glucoses and amino acids are filtered, and 100%re-absorbed. Proteins are not filtered.

IV-1.[1.0 points]

(Answer)

I-1	(1)
-----	-------

IV-2.[1.5 points]= 3 x 0.5 points

(Answer)

(X)	(Y)	(Z)
(0.0)g/100mL	(0.1)g/100mL	(0.0)g/100mL

constituent	Blood plasma	Primitive urine	urine
Water	92-93	92	95
Urea (Z)	0.03	0.03	2.00
Uric acid	0.004	0.004	0.05
Glucose (Y)	0.1	0.1	0
Amino acids	0.005	0.005	0
Minerals	0.9	0.9	0.9-3.6
Proteins (X)	8.0	0	0

unit (g/100mL)

IV-3.[1.5 points]= 3x 0.5 points

(Answer)

(X)	(Y)	(Z)
III	I, II Alternatives Only I or II: (0.25 points) Other: (0 point)	II



SOLUTION

V. Genetics

(Answer)

V-1	V-2	V-3
6	1/8	5' ----TAAGGTCA----3'

(Explanation)

V-1. [1.0 point] The answer is autosomal recessive. Because the individual 4 is an affected male, his genotype should be homo-recessive (aa). Thus, his offspring has to have at least one recessive allele. That is, although individuals 7 and 8 are both phenotypically normal, they have a mutant allele, respectively.

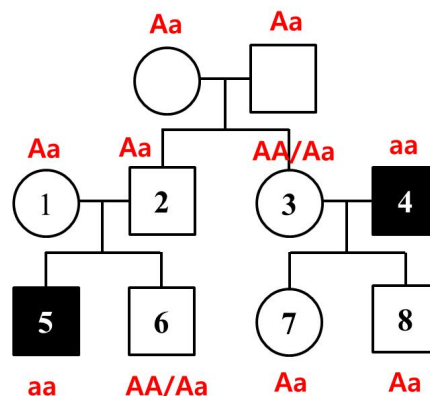

V-2. [1.0 point] Since individuals 1 and 2 already have an affected child, they must be heterozygotes. $Aa \times Aa \rightarrow AA, Aa, Aa, aa$. Therefore, the probability that a newly born female will be affected is $1/8$ ($1/4 \times 1/2$).

(1 point) for the correct answer

(1 point) for zero probability, if the answer to V-1 was 2

(0 point) for other options

V-3. [1.0 point] The nucleotide 'C' in [5'----TACGGTCA----3'] from the wild type has been replaced to 'A' in the mutant allele, making [5'----TAAGGTCA----3'].



VI. Blood Circulation

VI-1.[1.0 point]= 4 x 0.25 points

(Answer)

	Semilunar valves	Atrioventricular valves
t_1	Opened (○)	Closed(×)
t_2	Closed (×)	Opened(○)

(Explanation) Atrioventricular valves (AV valves) are thin flaps of tissue between the atria and ventricles. Semilunar valves lie at the openings from the ventricles into the arteries and prevent blood pumped out of the heart from returning to it. At t_1 of ventricle contraction, AV valves are closed while semilunar valves are opened. At t_2 of ventricle relaxation, semilunar valves are closed while AV valves are opened to fill ventricle out with blood.

VI-2.[1.0 point]

(Answer)

Heart rate	(75) beats/min
------------	------------------

(Explanation) Heart rate is beating number of heart per unit time (min). Referring to the graph, the second heartbeat comes in 0.8 sec after the first heartbeat.

$$\therefore \text{Heart rate} = \frac{1 \text{ beat}}{0.8 \text{ sec}} \times \frac{60 \text{ sec}}{1 \text{ min}} = 75 \text{ beats/min}$$

(1 points) for the correct answer

(0.5 points) for the correct calculation, if the answer is not correct

VI-3.[1.0 point]

(Answer)

Cardiac output	(5.25) L/min
----------------	----------------

(Explanation) Cardiac output is defined as the volume of blood pumped per ventricle per unit time.

It can be calculated by multiplying heart rate (beats per min) by stroke volume (mL/beat)

Cardiac output = heart rate X stroke volume

Stroke volume = Volume of blood before contraction - Volume of blood after contraction

By graph, stroke volume = 135 mL – 65 mL = 70 mL

$$\therefore \text{Cardiac output} = 75 \text{ beats/min} \times 70 \text{ mL/beat} = 5250 \text{ mL/min} (5.25 \text{ L/min})$$

(1 points) for the correct answer, according to the answer of the question VI.2

(0.5 points) for the correct calculation, if the answer is not correct